



Single Side Burner User Manual

Models: SB1
SB1L



ATTENTION:

INSTALLER: PLEASE LEAVE THESE INSTRUCTIONS WITH THE CONSUMER.
CONSUMER: PLEASE READ & RETAIN THESE INSTRUCTIONS FOR FUTURE REFERENCE AND BEFORE INSTALLING OR OPERATING.

 **DANGER**

If you smell gas:

- Shut OFF gas supply to the appliance.
- Extinguish any open flame.
- Open lid.
- If odor continues, keep away from the appliance and immediately call your gas supplier or your fire department.

 **WARNING**

- Do not store or use gasoline or other flammable liquids or vapors in the vicinity of this or any other appliance.
- An LP cylinder not connected for use shall not be stored in the vicinity of this or any other appliance.

This appliance is designed as an “**ATTENDED APPLIANCE**”.
DO NOT leave this appliance burning when unattended.

WARNINGS

READ THIS MANUAL CAREFULLY AND COMPLETELY BEFORE USING YOUR Side burner TO REDUCE THE RISK OF:

Fire, burn hazard, personal injury or property damage, improper installation or servicing electric shock.

THIS PRODUCT IS DESIGNED FOR OUTDOOR USE ONLY

Improper installation, adjustment, alteration, service or maintenance can cause property damage, injury or death. Read this manual thoroughly before installation, use, or servicing of this product.

CODE AND SUPPLY REQUIREMENTS:

This side burner must be installed in accordance with local codes and ordinances, or, in the absence of local codes, with the latest National Fuel Gas Code (ANSI Z223.1/NFPA 54), or Natural Gas and Propane Storage and Handling Installation Code (CSA-B149.1)

IF YOU SMELL GAS:

Shut off all gas supply lines to the side burner. Extinguish any open flames. Carefully open the lid. Remember, it may be extremely hot! If odor continues, keep everyone away from the side burner and immediately call your gas supplier or your fire department.

This appliance is designed as an “**ATTENDED APPLIANCE**”. **DO NOT** leave this appliance burning when unattended.

Minimum Ambient Operating Temperature:
0°F (-17.8 °C)

EXPLOSION HAZARD:

DO NOT use the side burner as a storage area for flammable materials. Keep area clear and free from combustible materials, gasoline, and other flammable vapors and liquids. Failure to do so can result in death, explosion, or fire. An LP cylinder not connected for use shall not be stored in the vicinity of this or any other appliance.

The outdoor cooking gas appliance and its dedicated shutoff valve must be disconnected from the gas supply piping system during pressure testing of that system at test pressures in excess of .5 psi (3.5kPa).

The outdoor cooking gas appliance must be isolated from the gas supply piping system by closing its dedicated manual shutoff valve during any pressure testing of the gas supply piping system at test pressures equal to or less than .5 psi (3.5kPa).

WARNING

NEVER cover slots, holes, or passage in the oven bottom or cover an entire rack with material such as aluminum foil. Doing so blocks air flow through the oven and may cause carbon monoxide poisoning.

Aluminum foil linings may trap heat causing a fire hazard.

CALIFORNIA PROPOSITION 65

WARNING

This product is designed to operate with one of the following fuel sources: Liquid Propane or Natural Gas. The fuel used to operate this product, and the products of combustion of such fuel, can expose you to chemicals including Benzene which is known to the State of California to cause cancer, birth defects and other reproductive harm and Carbon Monoxide which is known to the State of California to cause birth defects or other reproductive harm. (For more information go to: www.p65Warnings.ca.gov.)

TABLE OF CONTENTS

Warnings	2 & 4
Before Operating	5
Installation	6-7
Gas Requirements	8-10
Custom-Built Island	11
Lighting the Side burner	12
Operating/Maintenance Tips	13-14
Line Drawings	15
Replacement Parts	16
Illustrated Parts	17
Warranty	18
Gas Pipe Sizing Chart	19
Vent Hood Information	20
Refrigeration	21
Care & Cleaning	22

**PART #: SB1
SB1L**

(Natural Gas & Liquid Propane Gas Configurations)

For warranty information and to register your side burner visit, amddirect.com/register



To view on your phone, scan the QR code on your smart phone's camera app. (For Android devices, use Google Lens.)

THANK YOU

Thank you for your purchase. We'd like to welcome you to the Summerset Grills family of luxury outdoor kitchen products and look forward to being a part your home for years to come. As a family business with over 20 years of industry experience, we aim to deliver exceptional quality and personal service. Welcome to the Summerset Grills family and we hope you love your new side burner!

FOR YOUR RECORDS

Please record the following information and refer to it when contacting Summerset Grills or an authorized dealer. The serial number is located on the rating plate. The rating plate is located on the exterior basin of the side burner (fire box) and on the underneath side of the drip tray (select models only).

INSTALLER

Please leave this manual for the owner

Serial Number: _____

Model: _____

Date of Purchase: _____

Place of Purchase: _____

WARNINGS

SAFETY AND INSTALLATION WARNINGS

- Please read all instructions before installation or operating your side burner to prevent injury and appliance damage
- All side burners will get hot during use. Use extreme caution when operating the side burner
- Do not touch hot surfaces. Always use the handle to place or remove the side burner lid.
- Never use dented, rusty or damaged propane cylinders. Never store additional or empty propane cylinders in the side burner cabinet or in the vicinity of this or any other appliance
- Close supervision is necessary when this or any appliance is used near children. Keep children away from the side burner during operation and until the side burner has cooled off
- Children should never be left alone or unattended in an area where a side burner is located. Place your side burner well away from areas where children play. Do not store items that may interest children in or around the side burner, in the cart, or in the masonry enclosure
- Never move the side burner when hot. When in use, portions of the side burner are hot enough to cause severe burns.
- Always maintain the required clearances from combustibles as detailed. The side burner is designed for outdoor use only. Never use in a garage, building, shed, breezeway, or other enclosed area. Do not use this side burner under any unprotected overhead combustible construction
- Side burners are not designed or certified for and are not to be installed in or on recreational vehicles, portable trailers, boats or any other moving installation
- Always have an ABC Fire Extinguisher accessible — never attempt to extinguish a grease fire with water or other liquids
- Storing your side burner: Store your side burner in a well-ventilated area. If stored indoors, detach and leave L.P. cylinder outdoors in a well-ventilated area away from heat and away from where children may tamper with it
- Keep any electrical supply cord and the fuel supply hose away from any heated surfaces. Electrical cords should be placed away from walkways to avoid tripping hazard
- Do not repair or replace any part of the side burner unless specifically recommended in this manual. Other service should be performed by a qualified technician
- If the side burner is installed by a professional installer or technician, be sure that he/she shows you where your gas supply shut-off is located. All gas lines must have a shut-off that is readily and easily accessible. If you smell gas, check for gas leaks immediately. Check only with a soap and water solution. Never check for gas leaks with an open flame
- Do not twist the gas supply hose
- Inspect the L.P. gas supply hose prior to each use of the side burner. If there is evidence of excessive abrasion or wear, or the hose is cut, it must be replaced before using the side burner
- The use of accessories, regulators, or components not recommended by the appliance manufacturer may cause injuries and will void warranty
- Never light the side burner with the hood closed and be certain the burners are positioned and seated over the gas valves and on the burner support
- Never lean over the cooking surface when lighting or operating the side burner
- Use barbecue tools with wood handles and insulated oven mitts when operating the side burner
- Be sure the gas supplied to the side burner conforms to the model you purchased. A natural side burner requires natural gas to operate; a liquid propane side burner requires liquid propane to operate
- Never connect the appliance to an unregulated gas supply line. Side burners operated without a regulator are unsafe and will not be serviced until installed properly and safely. Unsafe operation without a gas regulator will void the warranty
- Side burners operating with natural gas must be installed with the NG regulator supplied with the unit and set to 4.0" of water column pressure
- Side burners operating with Liquid Propane must be installed with an LP regulator and set to 11" of water column pressure

BEFORE OPERATING

UNPACKING YOUR SIDE BURNER

Set of orifices

- If side burner is factory set LP, NG orifices will be included
- If side burner is factory set NG, LP orifices will be included

CHECK FOR SHIPPING DAMAGE:

VISIBLE DAMAGE

If your shipment arrives with visible damage to the box/carton, be sure the damage is noted on the bill of freight or express receipt and signed by the person making the delivery. File claim for damages immediately, regardless of the extent of damage.

CONCEALED DAMAGES

If damages are unnoticed until the side burner is unpacked, notify the transportation company or carrier immediately and file a concealed damage claim with them. This should be done within (5) days of the delivery date. Be sure to hold on to the box/carton for inspection. We cannot assume responsibility for damage or loss incurred in transit.

IMPORTANT NOTES:

BE MINDFUL OF WIND DIRECTION

Using your side burner in windy conditions may disrupt the front-to-back air flow that the side burner is designed for. If you notice that the temperature gauge fails to rise while side burnering with all burners on high and the hood closed, then be careful. If wind keeps the heat from exiting the rear of the side burner, then the control panel and knobs could become extremely hot. Your side burner pulls air in through its front and vents hot gases out the rear hood; do not side burner if wind is entering the rear hood of the side burner.

GAS LINE LENGTH

Keep all gas supply lines as short as possible. Gas lines lose pressure over distance and with each elbow or "T" fitting added. This drop in pressure affects side burner performance.

**See Gas Pipe Sizing Chart on page 19*

PROPER LEVELING

PROPER LEVELING DURING INSTALLATION IS CRITICAL. A SIDE BURNER THAT IS OUT OF LEVEL WILL CAUSE ERRATIC BURNER COMBUSTION AND INEFFICIENT, UNEVEN HEATING. THE SIDE BURNER SHOULD BE LEVEL IN ALL DIRECTIONS. ADJUSTMENTS MAY NEED TO BE MADE EACH TIME WHEN MOVING A FREESTANDING UNIT.

CONSTRUCTION ZONES

Keep all stainless steel products away from construction zones. Construction debris such as (but not limited to) stone dust, stucco, and lime dust could damage or permanently discolor stainless steel products. Keep all caustic chemicals including chlorine and pool cleaning products away from stainless steel at all times.

INSTALLATION

The TRL Pro can be used as a built-in unit or with a Summerset side burner cart. For installation as a built-in, it requires a non-combustible island or enclosure. Use Figure 1 and Table 1 as a guide.

It is recommended to use cement board with steel studs and proper ventilation per local codes. A minimum 4-inch vent size is required, one at the top and one at the bottom to provide free flowing air keep the island cool during operation of the side burner.

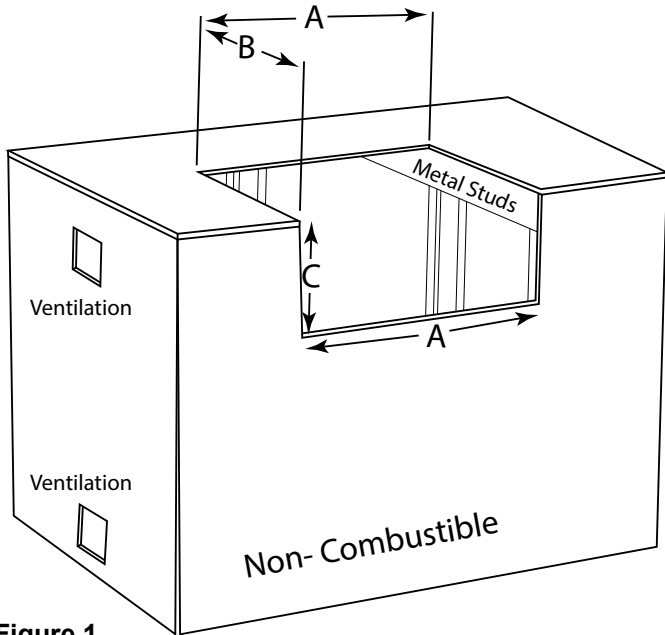

Figure 1

⚠ ALL BBQ ISLANDS MUST BE MANUFACTURED FROM "NON COMBUSTIBLE" MATERIALS.

ISLAND CUT OUT DIMENSIONS

SIDE BURNER MODEL	A: WIDTH	B: DEPTH	C: HEIGHT
SB1	8"	15-1/2"	2-1/2"

Table 1

OVERALL PRODUCT DIMENSIONS

SIDE BURNER MODEL	A: WIDTH	B: DEPTH	C: HEIGHT
SB1	14"	19-5/8"	5-3/4"

Table 2

Note: Refer to page 10 for Custom Built-In Enclosures/ Islands when building.

MINIMUM SIDE BURNER CLEARANCES:

Minimum clearances between the side burner and any side wall or rear wall must fall within one (or more) of the following:

IMPORTANT NOTE:

Clearance from the side burner and a non-combustible wall

(i.e. brick wall, see Figure. 2). The side burner requires a minimum of 4" clearance from the right side, left side and rear (back) of the side burner from any non-combustible wall. This allows for proper ventilation and helps prevent dangerous overheating.

If a non-combustible backsplash exists, it must have a minimum of a 4" clearance from the rear of the side burner (to allow for proper ventilation and help prevent dangerous overheating. Clearance Figure 2).

Non-Combustible Backsplash

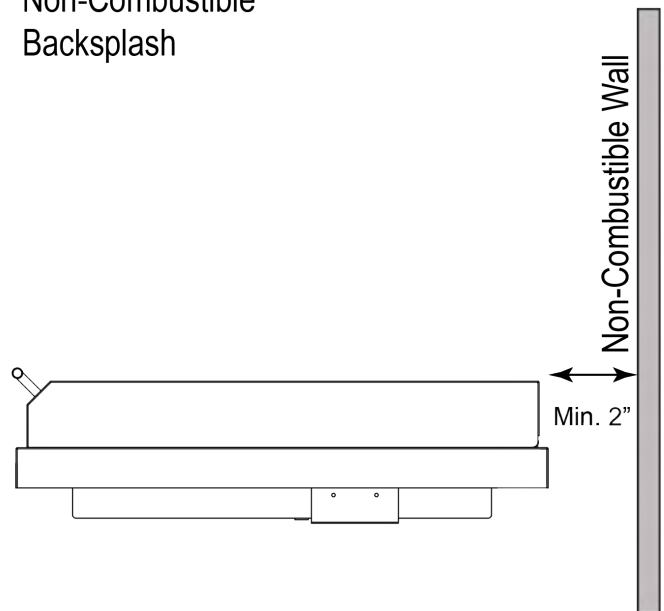

Figure 2

IMPORTANT NOTE:

This 4" backsplash clearance must first be met prior to any non-combustible walls beginning behind it.

The side burner must have a minimum of 14" clearance from the right side, left side and rear (back) of the side burner from a protected combustible wall. Refer to Figure 3.

INSTALLATION

Clearance from the side burner and protected combustible wall (i.e. A non-combustible wall in front of a combustible wall to serve as a barrier. This can be accomplished by brick or a metal stud finished with non-combustible substrate.

See Figure 3). The side burner must have a minimum of 14" right, left and rear clearance from the protected combustible wall. (4" non-combustible material clearance, plus an additional 10" clearance between the side burner and protected wall.)

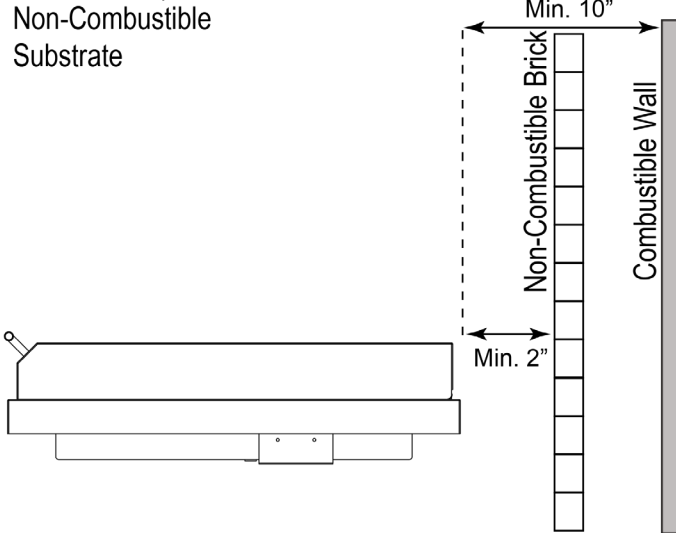

Figure 3

Clearance from the side burner and combustible wall

(Clearance Figure 4). The side burner must have a minimum clearance of 16" from the right side, left side and rear of the side burner to any combustible wall.

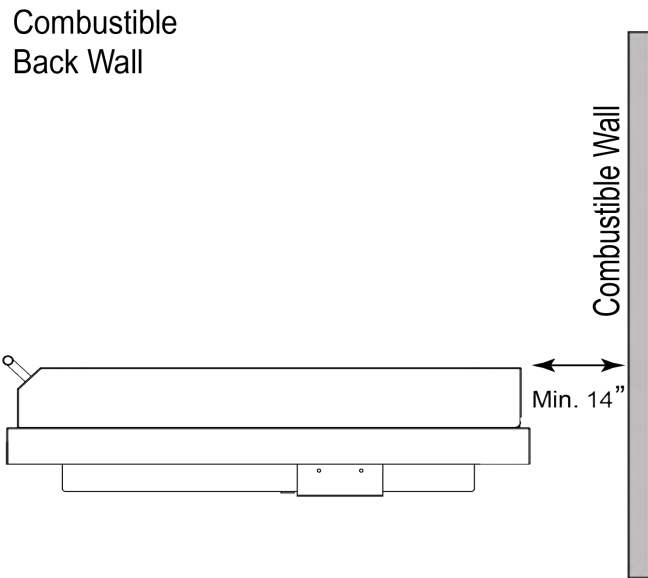

Figure 4

OVERHEAD CONSTRUCTION AND EXHAUST HOOD REQUIREMENTS

This side burner is designed for outdoor use only. **DO NOT** use this side burner inside a building, garage, or enclosed area.

DO NOT use this side burner in or on a recreational vehicle or boat.

When installing this side burner in a combustible surround, a

Summerset Side burners insulating jacket/side burner liner must be used.

A minimum five (5) foot clearance is required between the countertop and the overhead construction.

When the side burner is installed under a combustible overhead construction, the area above the cooking surface of the side burner must be used with an exhaust hood. The exhaust hood provides the protection for the combustible overhead construction. See Figure 5.

IMPORTANT NOTE:

- DO NOT use this appliance under unprotected combustible overhead construction.
- When installed under overhead non-combustible construction, an exhaust hood is highly recommended.

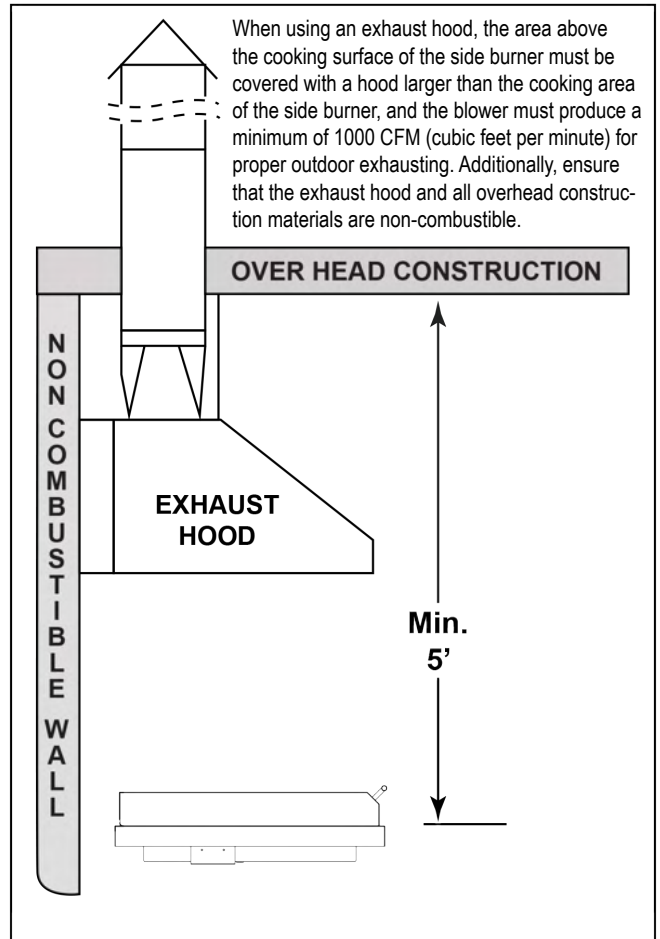

GAS REQUIREMENTS

WARNING

GAS LINES

Never connect a gas line directly to the side burner. A pressure regulator must be installed on all gas equipment. Removing or failing to install the pressure regulator can result in fire and serious personal injury and will void the warranty

GAS PRESSURE REQUIREMENTS

Ensure the gas supplied meets the minimum pressure requirements. See Table 3 for gas requirements measure in Water Column (W.C.) pressure.

Pressure	Natural Gas	Propane Gas
Min. Inlet	4.0" WC (1.00.kPa)	10.0" WC (2.49 kPa)
Max. Inlet	7.0" WC (1.74 kPa)	14.0" WC (3.48 kPa)

Table 3

NOTE: Both the regulator and burner orifices have been tuned for the type of gas specified on the rating plate. Converting to a different type of gas requires a conversion kit. Conversion kits are included with this side burner and located with the manual. Converting gases may require additional parts not included with this side burner. (See Gas Conversion section for details).

NATURAL GAS REQUIREMENTS

- Summerset Side burners recommends that only qualified professionals perform the required plumbing on this product.
- Check the Rating Plate to make sure the gas supply you are hooking up to is the gas type the side burner is manufactured for.
- To ensure satisfactory performance, the gas supply line must be sized to accommodate the total BTU requirements of all the gas-fired equipment that will be connected to that line.
- In no case should pipe less than 1/2" inside diameter or 1" outside diameter ever be used to connect this product.

CONNECTING TO THE NG REGULATOR

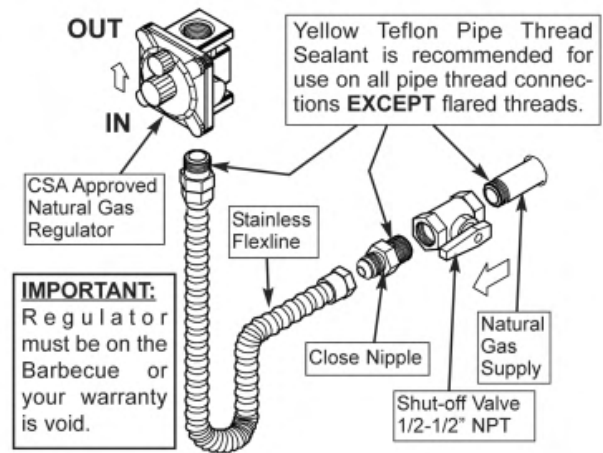

Figure 6

NOTE: DO NOT use any tape, pipe dope or threading compound on any flare fitting. This will cause a clog in the regulator and prevent your side burner from functioning properly.

MAIN & REAR BURNER BTU INFORMATION

Burner Type	SB1	SB1L
Total BTU	15,000	15,000

Table 4

GAS REQUIREMENTS

SAFE USE AND MAINTENANCE OF PROPANE GAS CYLINDERS

IMPORTANT FOR YOUR SAFETY
READ AND FOLLOW ALL WARNINGS PROVIDED WITH THE PROPANE GAS CYLINDER.
When operating a Propane gas cylinder, these instructions and warnings **MUST** be observed.
FAILURE TO DO SO MAY RESULT IN A SERIOUS FIRE OR EXPLOSION

CYLINDER/CONNECTOR REQUIREMENTS

- a. Propane gas cylinders, valves and hoses must be maintained in good condition and inspected before each use of an appliance. They must be replaced if there is any visible damage. If the hose is cut or shows any excessive abrasion or wear, it must be replaced before using the appliance. (See section e.)
- b. This unit, when used with a portable cylinder, should be connected to a standard 5-gallon (20 lb.) propane gas cylinder equipped with a listed overfilling prevention device.
- c. Cylinder dimensions should be approximately 12" (30.5cm) in diameter and 18" (45.7cm) high. Cylinders must be constructed and marked in accordance with the U.S. Department of Transportation (D.O.T.) Specifications for LP-Gas Cylinders, or the standard for Cylinders, Spheres, and Tubes for Transportation of Dangerous Goods and Commission, CAN/CSA-B339, as applicable.
- d. The cylinder used must include a collar to protect the cylinder valve, and the cylinder supply system must be arranged for vapor withdrawal.
- e. The pressure regulator and hose assembly used must match the specification for Type I by ANSI Z 21.58/CGA 1.6 (See Figure 7)
- f. The propane gas cylinder valve must be equipped with a cylinder connection device, described as Type I in the standard defined in paragraph "e" above. This device is commonly describes as an Acme thread coupler.
- g. If the propane gas cylinder comes with a dust cap, place the dust cap on the cylinder valve outlet whenever the cylinder is not in use.

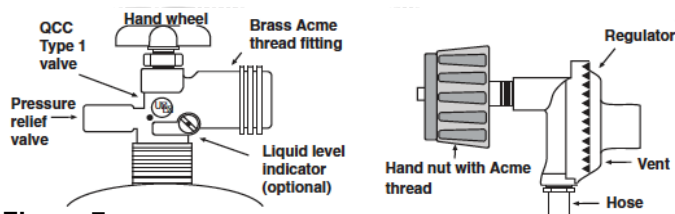

Figure 7

COUPLER OPERATION

To connect the regulator/hose to the Propane gas cylinder valve fitting:

Press the hand nut on the regulator over the Acme thread fitting on the cylinder valve. Turn the hand nut clockwise to engage the threads and tighten until snug. The pliers of a wrench should not be necessary. Only cylinder marked "Propane" may be used.

To Disconnect:

Turn the hand nut counterclockwise until detached. See Figure 7.

IMPORTANT: Before using the unit, and after each time the cylinder is removed and reattached check the hose for wear (See section "a") and check all connections for leaks. Turn OFF the unit valves and open the main cylinder valve, then check connections with soapy water. Repair any leaks before lighting the unit.

CAUTION: Always turn the Propane cylinder main valve OFF after each use, and before moving the unit and cylinder or disconnecting the coupling. This valve must remain closed and the cylinder disconnected while the appliance is not in use, even though the gas flow is stopped by a safety feature when the coupler is disconnected.

Carefully inspect the hose assembly each time before the gas is turned ON. A cracked or frayed hose must be replaced immediately.

If the appliance is stored indoors, the cylinder must be disconnected and removed. Disconnected cylinders must be stored outdoors, out of reach of children, with threaded valve plugs tightly installed, and must not be stored in a building, garage, or any other enclosed area.

FOR YOUR SAFETY

- DO NOT store a spare Propane gas cylinder under or near this appliance.
- NEVER fill the cylinder beyond 80% full.
- IF THE INFORMATION IN SECTIONS "a" AND "b" IS NOT FOLLOWED EXACTLY, A FIRE CAUSING DEATH OR SERIOUS INJURY MY OCCUR.

For proper ventilation and enclosure requirements, see the Enclosure Installation and Ventilation Requirements on pages 6 and 11.

GAS REQUIREMENTS

CONNECTING TO A SIDE BURNER

You will need a 'T' adapter fitting (not provided) or similar connection to connect a single gas line to both a side burner and a side burner. We recommend a licensed gas technician install all gas lines. See below Figure 8 for installation of a 'T' adapter.

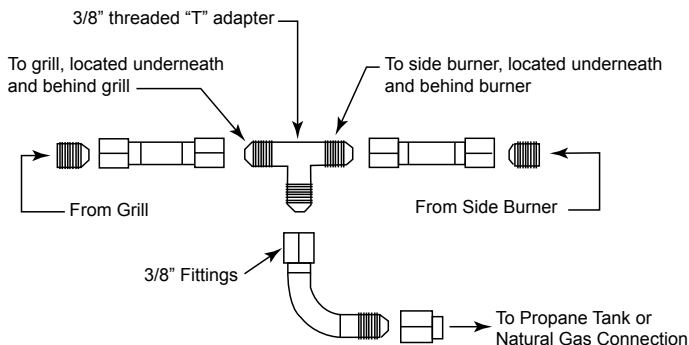

IMPORTANT:

Ventilation is required in the enclosure and recommended on opposite sides. Liquid Propane is heavier than Natural Gas and vents should be located near the bottom of the enclosure. In some applications, there will be free air space at the bottom of the enclosure which can act as the ventilation.

TESTING FOR LEAKS

Create a soapy water solution of 1 part soap and 3 parts water. Confirm that all control knobs are in the off position. Turn on the fuel supply.

For Natural Gas, turn the valve handle ¼ turn to align with the gas flow. For LP, turn the cylinder valve counter clockwise one full rotation. Apply the soap solution generously by paint brush or squirt bottle on all connections and fittings. If bubble appear to grow on any of the connections, you have a gas leak. IMMEDIATELY turn OFF the gas supply. Wash off the soapy solution with cold water and dry. Tighten the loose joint or replace the faulty part with manufacturer-recommended replacement parts.

DO NOT attempt to repair the L.P. cylinder valve if it is damaged. The only way to safely resolve a damaged cylinder is to replace it by calling an authorized gas appliance service technician or an LP gas dealer. Repeat the leak test to ensure that no leaks are present. Do not use the appliance until the leak is corrected.

LIQUID PROPANE INSTALLATION

LP side burner models are designed for use with a standard 20 lb. liquid propane gas (LP) tank with type (1) valve connections. (Not included)

A professional plumber or Gas technician can adapt an LP side burner to your home's bulk LP gas supply. Connecting a side burner to a home propane tank is not recommended because of the risk of losing large amounts of propane. Even if you turn off the side burner supply, leaks can still happen, and pests like squirrels and mice are known to chew on propane lines.

A dented or rusty LP tank may be hazardous and should be avoided. If in doubt, have it checked by your LP supplier. Always check for leaks after every LP tank change. (See Checking For Leaks)

LP Tanks must be stored outdoors in a well-ventilated area out of the reach of children. If your side burner is stored indoors, the LP tank must be stored outside, in upright position and away from excessive heat.

IMPORTANT:

All installation and all installation parts must conform to local codes with the National Electrical Code, ANSI Z223.1/ NFPA 70 latest edition and the National Fuel Gas Code ANSI Z223.1/NFPA 54 in the U.S. and CGA-B149.1/.2 in Canada

PROPANE GAS TANK REQUIREMENTS

FILLING AND REFILLING LP GAS CYLINDERS

All purging and refilling of LP gas cylinders must be performed by qualified personnel in the LP gas industry. Never store a spare LP gas cylinder under or near this appliance.

Never fill the LP gas cylinder beyond 80 percent full. Failure to follow these instructions may result in explosion, personal injury or death.

CUSTOM-BUILT ENCLOSURES/ ISLANDS

VENTILATION RECOMMENDATIONS FOR ALL ENCLOSURES

FOR ALL GAS TYPES:

Natural Gas, Household Propane or LP Cylinder/Tanks

FOR YOUR SAFETY, you should provide the openings listed below for replacement air and ventilation of the side burner enclosure (i.e. in case of possible gas leaks from connections or LP tanks/cylinders). Failure to do so may result in a fire or explosion causing property damage, bodily injury or death.

One side of the enclosure shall be kept completely open to the outside OR ventilation openings MUST be provided:

- Each opening should have a minimum of 10 sq. in. of free area. The openings should be equally sized, providing a total of 40 sq. in.
- Two openings should be in the side walls of the enclosure, at the top and spaced a minimum of 90° from each other. The openings should begin 1" or less below the countertop edge and end no more than 5" below the countertop edge. See Figure 9.
- Two openings should be in the side walls of the enclosure, at the bottom (floor level) and spaced a minimum of 90° from each other. The openings should begin 1" above the floor level and end no more than 5" above floor level.
- **The openings must remain unobstructed:** The clearance between the openings and any items outside of the enclosure is a minimum of 6". The clearance between the openings and any items within the enclosure is a minimum of 2". This provides free flowing air inside and outside the enclosure to keep the island cool during operation of the side burner. See Figure 9.
- An appliance is considered to be outdoors if installed with shelter no more inclusive than with walls on three sides, but with no overhead cover; all openings must be permanently open; sliding doors, garage doors, windows, or screened openings are not considered as permanent openings.
- An appliance is considered to be outdoors if installed with shelter no more inclusive than within a partial enclosure that includes an overhead cover and no more than two sidewalls. The sidewalls may be parallel, as in a breezeway, or at right angles to each other; all openings must be permanently open; sliding doors, garage doors, windows, or screened openings are not

considered as permanent openings.

- An appliance is considered to be outdoors if installed with shelter no more inclusive than within a partial enclosure that includes an overhead cover and three sidewalls, as long as 30% or more of the horizontal periphery of the enclosure is permanently open. All openings must be permanently open; sliding doors, garage doors, windows, or screened openings are not considered as permanent openings.

VENTILATION RECOMMENDATIONS

- Minimum 4 openings (2 per side wall spaced at 90°)
- Top openings: within 5" of countertop
- Bottom openings: within 5" of floor
- Each vent opening: Min. 10 sq. in. of free area (Total to = 40 sq. in.)

Vent openings must be kept clear and free at all times.

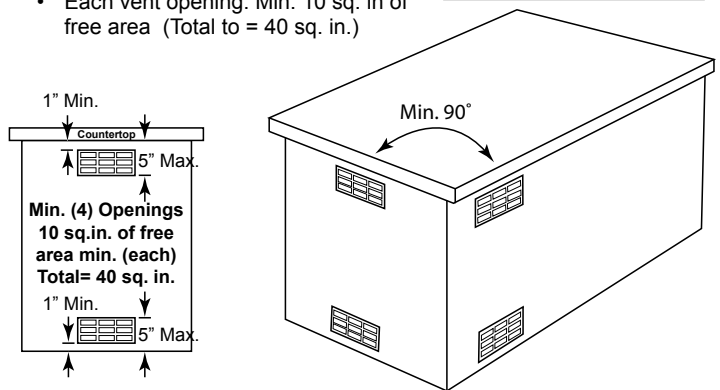

Figure 9

UNOBSTRUCTED VENT OPENINGS

- 6" Minimum clearance in front of all vent openings to any items outside the enclosure
- 2" Minimum clearance in front of all vent openings to any items inside the enclosure

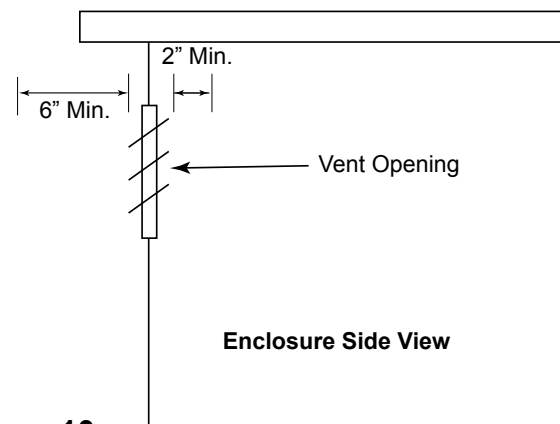

Figure 10

OPERATION

READ INSTRUCTIONS BEFORE LIGHTING

ELECTRONIC SPARK IGNITION

CAUTION: Keep your face and body away from the side burner top when lighting

Open the hood before lighting; do not attempt to ignite burners while hood is closed.

Make sure gas supply is turned ON.

Make sure burner control knobs are in the “OFF” position. DO NOT turn on more than one valve at a time for initial ignition.

1. Press in the control knob then slightly turn the knob counterclockwise while still pressing inward.
2. Hold in the above position for 5 seconds allowing the gas to reach the manifold.
3. While the knob is pushed in, you will hear a consistent clicking sound from the electronic ignition.
4. If burner does not light in 5 seconds, turn the burner control(s) OFF, wait 5 minutes, and repeat steps 1-3. Gas may need to be primed several times to fill gas manifold ignition.
5. After ignition, set the knob to the desired setting.

READ INSTRUCTIONS BEFORE LIGHTING

MANUAL (MATCH LIGHT) IGNITION

CAUTION: Keep your face and body away from the side burner top when lighting

Open the hood before lighting; do not attempt to ignite burners while hood is closed.

Make sure gas supply is turned ON.

Make sure burner control knobs are in the “OFF” position. DO NOT turn on more than one valve at a time for initial ignition.

1. Follow steps 1-3
2. Place either a burning long-barrel butane lighter or a burning long-stem match near the manual flash tube to the right of the side burner. For back burners, hold the flame against the surface of the back burner.
3. Hold the lighter or match flame at the top of the manual flash tube for five (5) seconds, or, next to the back burner. Then depress the appropriate control knob and while pressing turn it counterclockwise to the HI position. Remove the lighter or match when the burner lights and release the control knob.
4. If burner does not light in 5 seconds, turn the burner control(s) OFF, wait 5 minutes, and repeat steps 1-3. Gas may need to be primed several times to fill gas manifold ignition. After ignition, set the knob to the desired setting.

SHUT OFF INSTRUCTIONS

1. To shut OFF the side burner, depress each valve control knob and while pressing turn clockwise to the “OFF” position.
2. Always close the valve from the gas supply after each use of the side burner.

This appliance is designed as an “**ATTENDED APPLIANCE**”.
DO NOT leave this appliance burning when unattended.

Check and clean burner/venturi tubes for insects and insect nests. A clogged tube can lead to a fire beneath the side burner.

OPERATION & MAINTENANCE TIPS

PRE-HEATING THE Side burner

Pre-heating your side burner every time you use it is extremely important. Pre-heating allows the briquettes to properly heat up, providing more even and more consistent cooking results. Pre-heat your side burner by igniting all main burners. Then close the hood and allow the side burner to heat for 10 to 15 minutes, the hood thermometer should reach approximately 450°. Once you've reached your desired pre-heat temperature, turn OFF the burners that you won't be using to cook your food. Remember, surface temperature can be up to 200° higher.

SHUT OFF INSTRUCTIONS

1. To shut off the unit, depress each valve control knob and while pressing turn clockwise to the "OFF" position.
2. Always close the valve from the gas supply after each use of the unit.

NOTE:

When using a portable Propane tank: Propane tanks are equipped with a safety shutdown device that may cause low or no gas pressure/ flame at the burners if operating and lighting instructions are not followed exactly.

ADJUSTING YOUR BURNER TO A LOWER SETTING

- Make sure the side burner is cool
- Remove the racks so you can see the flames while adjusting the burners
- Light the burner
- Turn the burner to "LOW"
- Pull off the control knob
- Use a flat head screw driver and adjust the "gold flathead screw" in the valve to the proper flame height

MAINTENANCE TIPS

Stainless steels need to be cleaned for aesthetic considerations and to preserve corrosion resistance. Stainless steel is protected from corrosion by a thin layer of chromium oxide. Oxygen from the atmosphere combines with the chromium in the stainless steel to form this passive chromium oxide film that protects from further corrosion.

EXTERIOR STAINLESS STEEL CLEANING

Fill a bucket with warm water and soap (Dawn or Simple Green)

- Using a microfiber towel or sponge moistened with soapy water, wipe down the surface of the side burner following the grain of the metal as you clean.
- Rinse completely with clean water.
- Dry with a microfiber towel.

- Using Bar Keepers Friend, Zep or other quality stainless steel cleaners helps to protect the porous stainless-steel surface from discoloration.
- Covering side burner using a side burner cover, when not in use, is a great way to protect the exterior.

MONTHLY INTERIOR CLEANING

- Turn side burner on high for 15 minutes, close hood "like self-cleaning ovens" to burn up and brake down any interior buildup of greases and food residue.
- Let side burner cool down for roughly 90 minutes.
- Remove the cooking grates. Soak them in a bucket of warm water with Simple Green to remove baked on grime and grease.
- Remove the drip tray and scrape off any residue. Then, spray with Simple Green and hose off.
- Remove briquette tray and brush off any residue.
- Wipe down interior walls around back burner and side walls using a degreaser or stainless steel cleaner for ovens and side burners.
- Remove the bottom burners. Lightly brush them off with a stainless or steel brush. Clean out the holes on the burner, making sure none are clogged.
- Turn and tap them with the main inlet hole down to remove debris from inside.
- Use a stainless or steel brush or putty knife to scrape down the interior basin of the side burner.
- Using some type of shop vac, vacuum out the residue from the bottom basin of the side burner.
- If desired, hose out inside of side burner. Then let dry before reinstalling interior parts.
- After each use burn off debris and brush clean.

RUST INFORMATION

Rust-like brown spots on stainless steel form when oxygen comes into sustained contact with iron, a process called oxidation. This occurs when water, from rain or humidity, delivers oxygen to the metal. Carbon dioxide in the air combines with water to create a weak carbonic acid, which breaks down into hydrogen and oxygen, causing rust-like deposits on the surface. These deposits can form in the pores of the stainless steel, especially in architectural crevices like polished welds and edges that trap liquids. Once these spots form, they can trap more liquids and worsen over time.

REMOVE RUST LOOKING STAINS OR SPOTS

- Mix 1 tablespoon of baking soda in 2 cups of water.
- Rub the baking soda solution on the rust stain using a toothbrush, being careful to go with the grain of the stainless steel. If the stain is persistent, add vinegar, little by little, to a cup of baking soda until you have a consistent paste. Wipe the spot with paste and rinse with a wet microfiber towel. Making certain you always wipe in the direction of the grain of the stainless steel.
- When stain is removed, wash entire surface with the soap solution mentioned above. For grease build up, use Zep on the exterior surface to remove.

MAINTENANCE TIPS

IMPORTANT NOTE: FOR LOCATIONS NEAR COASTAL AREAS AND POOLS:

#304 stainless steel materials used in the construction of your TRL Pro Side burner are highly rust resistant, however, chlorine in the air from swimming pools or the salt from sea air may cause surface rust to appear and even create some pitting if left on the product. Here are a few tips to avoid this if instructions are not followed exactly.

- Regularly wipe down the exterior surfaces with a damp cloth (micro fiber towels work well).
- Allow the surfaces to dry before installing the cover. Do not cover a damp side burner
- In extreme environments apply a rust inhibitor which leaves a microscopic protective layer on the side burner.
- For seasonal storage use the product referred to above, ensure the side burner is dry, then cover and secure the cover to minimize the amount of damp air getting to the surfaces.

After your first use, certain areas of the side burner may discolor from the intense heat given off by the burners; this is normal and cannot be cleaned off. For light and heavy food stains there are many different stainless; steel cleaners available.

LINE DRAWINGS

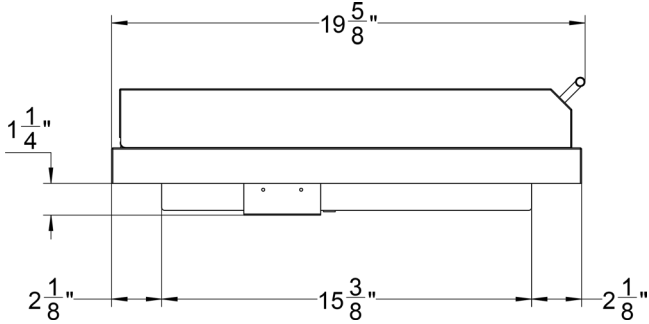
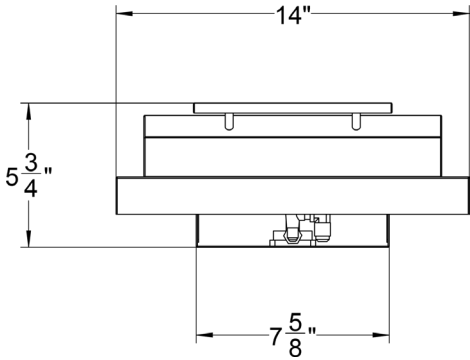
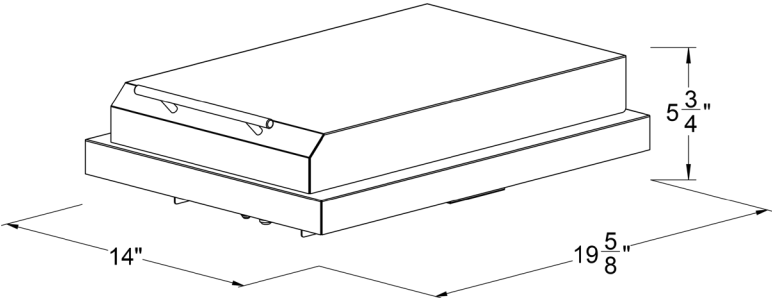

REPLACEMENT PARTS

ITEM	DESCRIPTION	QTY.
1	LID HANDLE	1
2	LID	1
3	GRATE	1
4	BURNER	1
5	IGNITER	1
6	LP ORIFICE 1.22mm	LP Model
	NG ORIFICE 1.6mm	NG Model
7	BURNER BASE	1
8	HINGE	2
9	KNOB	1
10	KNOB BEZEL	1
11	VALVE	1
12	IGNITER WIRE	1
13	MANIFOLD	1
14	BODY	1

ILLUSTRATED PARTS

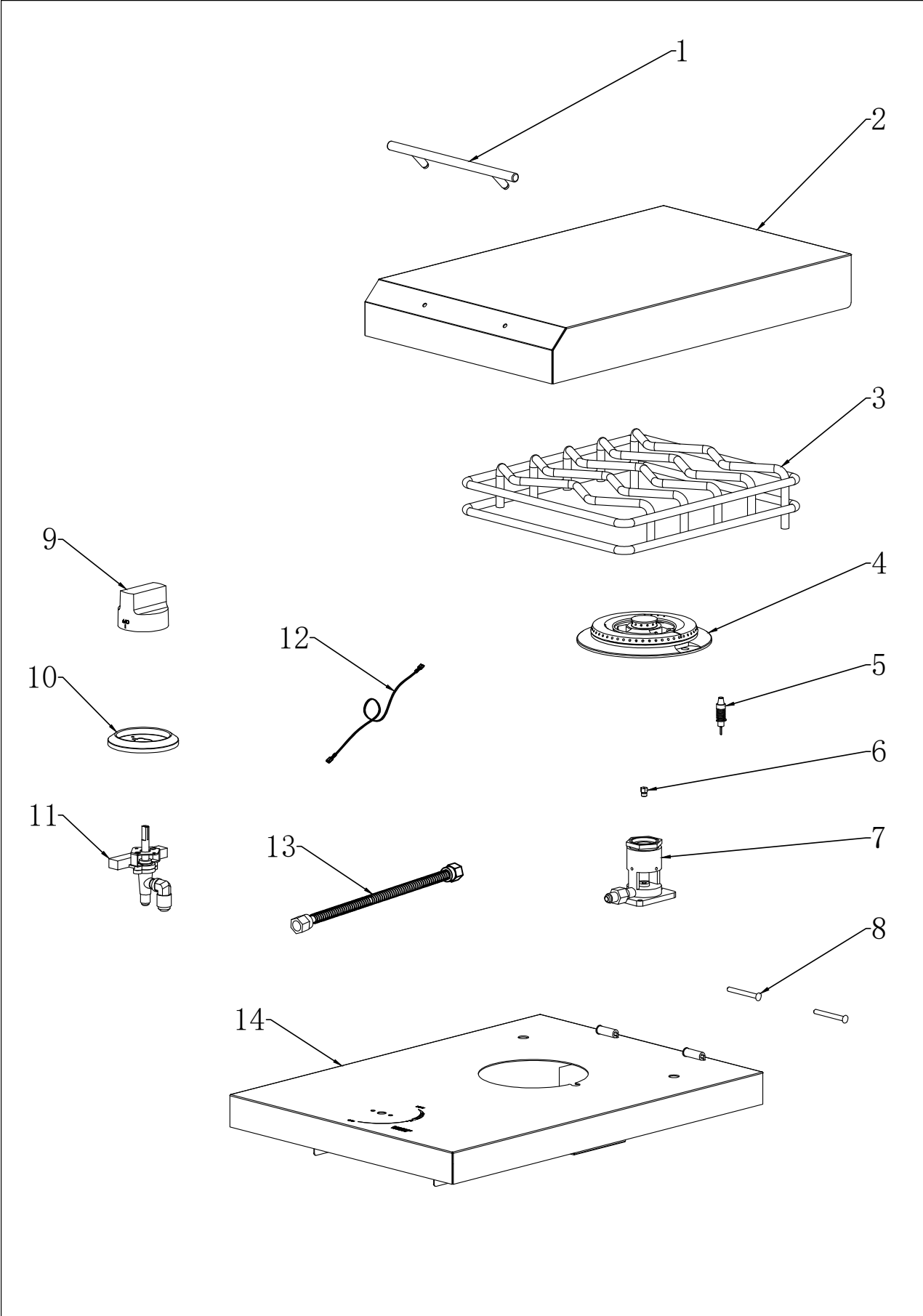

WARRANTY



Your investment in AMD Direct products is backed by the strongest warranty in the industry. In addition to precision engineering and outstanding performance, AMD Direct products include our GOLD STANDARD LIFETIME WARRANTY with all replacement parts 100% non-prorated. Effective with purchases as of 3/1/23.

AMD Direct Warranty is valid for original purchaser at original site of delivery with proof of purchase and photo documentation only. Registration form must be submitted online within 30 days of the purchase date to validate the warranty. Warranty is void upon transfer of ownership. Warranty does not apply to products installed in any commercial, rental, or nonresidential application (exception of the Resort Grill, Alturi, & TRL). Warranty covers replacement parts only. Manufacturer is not responsible for labor or labor-related costs. Warranty does not cover discoloration, surface rust, corrosion, or oxidation, which may occur due to harsh environments, chemicals, or overheating. Warranty will not apply for damage resulting from improper installations, abuse, extreme environments, grease fires, or misuse. Proof of regular and proper maintenance is required. Coastal, humid, and/or salt environments are subject to manufacturer review. All out-of-box claims must be made within 30 days of purchase and must be made prior to installation. Any product installed damaged will be considered damaged during installation and not covered under warranty. Warranty and registration forms are available at www.amddirect.com/register. Please be advised - all display models are sold "as is" and the warranty covers the following items only: main burners (Gold Standard Lifetime Warranty), grates (Gold Standard Lifetime Warranty), burner covers (Gold Standard Lifetime Warranty). All warranties are subject to the review and approval of the manufacturer.

**14520 DELTA LANE SUITE 105
HUNTINGTON BEACH, CA 92647
800.966.8126
AMDDIRECT.COM**

AMD DIRECT GAS APPLIANCES, GRILLS, SIDE/POWER BURNERS, & GAS OVEN

Gold Standard Lifetime Warranty on construction and manufacturer defects

- Gold Standard Lifetime Warranty on stainless steel construction
- Gold Standard Lifetime Warranty on cooking grates, burners, burner covers, valves, flame tamers, and heat zone separators, temperature gauges, & hood springs
- Gold Standard Lifetime Warranty on briquette systems
- 3 YEAR Warranty on all other parts, components, & electrical, including: LED bulbs, wire harness, & switches; power source wire; transformer; interior halogen light wire & bulb

VENT HOODS, REFRIGERATION, COLD STORAGE & SINKS VENT HOODS

- 5 Year Warranty on all Stainless Steel Construction
- 3 year Warranty on blowers, LED Lighting, wiring harness and switches

15" & 24" REFRIGERATION MODELS

- 3 year Warranty on all construction including compressors
- 1 year Warranty on transformer, LED bulbs, LED harness, power source wire, LED switches, interior halogen light wire/bulbs

22" REFRIGERATION MODELS

- 1 year Warranty on all construction & electrical components including compressor, transformer, LED bulbs, LED harness, power source wire, LED switches, interior halogen light wire/bulbs

COLD STORAGE & SINKS

- Gold Standard Lifetime Warranty on Ice Chests• Gold Standard Lifetime Warranty on drains & faucets

DRAWERS, DOORS, GRILL LINERS, & CARTS

- Gold Standard Lifetime Warranty on construction, workmanship and materials for all stainless steel parts, including doors, drawers, side burner liners, & carts
- 3 year on electrical (Warming Drawers)

COVERS

- Gold Standard Lifetime Warranty on covers, including side burners, carts, side/power burners & oven

COMMERCIAL APPLICATIONS

RESORT & TRLPRO GRILLS

- Gold Standard Lifetime Warranty on workmanship, construction, & manufacturer defects for all commercial and/or hospitality applications
- Warranty is void upon misuse, including lack of regular cleaning, vandalism, or theft
- Warranty is valid only if regular maintenance is exercised. Due to the nature of commercial applications (multiple users, lack of control of use, etc.) regular maintenance is mandatory.

GAS PIPE SIZING CHART

NATURAL GAS : PIPE SIZING CHART

Length of Pipe in Feet	1/2"	3/4"	1"	1 - 1/4"	1 - 1/2"	2"	2 - 2 1/2"	3"	4"
10	108	230	387	793	1237	2259	3640	6434	-
20	75	160	280	569	877	1610	2613	5236	9521
30	61	129	224	471	719	1335	2165	4107	7859
40	52	110	196	401	635	1143	1867	3258	6795
50	46	98	177	364	560	1041	1680	2936	6142
60	42	89	159	336	513	957	1559	2684	5647
70	38	82	149	317	476	896	1447	2492	5250
80	36	76	140	239	443	840	1353	2315	4900
90	33	71	133	275	420	793	1288	2203	4667
100	32	68	126	266	411	775	1246	2128	4518
125	28	60	117	243	369	700	1143	1904	4065
150	25	54	105	215	327	625	1008	1689	3645
175	23	50	93	196	303	583	993	1554	3370
200	22	47	84	182	280	541	877	1437	3160
300	17	37	70	145	224	439	686	1139	2539

- Natural Gas (NG) flow is given in thousands of BTU/hr. = 1 cubic foot of NG gas - 1000 BTU
- Nominal pressure at the burner for Natural Gas is 3.5" of water column. (Typical machine supply 5"-7")
- Pipe length must include additional length for all fittings. Add approximately 5 feet of pipe per fitting.
- Natural Gas Example: A machine with a burner that requires 440,000 BTU would need a 1 - 1/4" pipe for a 20" long run.

LIQUID PROPANE : PIPE SIZING CHART

Length of Pipe in Feet	1/2"	3/4"	1"	1 - 1/4"	1 - 1/2"	2"	2 - 2 1/2"	3"	4"
10	275	567	1071	2205	3307	6221	10140	17990	35710
20	189	393	732	1496	2299	4331	7046	12510	25520
30	152	315	590	1212	1858	3465	5695	10110	20620
40	129	267	504	1039	1559	2992	4778	8481	17300
50	114	237	448	913	1417	2646	4343	7708	15730
60	103	217	409	834	1275	2394	3908	6936	14150
70	89	185	346	724	1086	2047	3329	5908	12050
80	78	162	307	630	976	1811	2991	5309	10830
90	69	146	275	567	866	1606	2654	4711	9613
100	63	132	252	511	787	1496	2412	4281	8736
125	54	112	209	439	665	1282	2083	3618	7382
150	48	100	185	390	590	1138	1808	3210	6549
175	43	90	168	353	534	1030	1637	2905	5927
200	40	83	155	325	491	947	1505	2671	5450
300	37	77	144	303	458	887	1404	2492	5084

- Liquid Propane (LP) Gas flow is given in thousands of BTU/hr. = 1 cubic foot of LP gas - 2500 BTU.
- This chart refers to low pressure LP, after regulation. Standard nominal pressure at the burner for Liquid Propane Gas is 11" of water column.
- Pipe length must include additional length for all fittings. Add approximately 5 feet of pipe per fitting.
- LP Example: A machine with a burner that requires 440,000 BTU would need a 1" pipe for a 20' long run.

NOTE: The sizing charts above list the specific pipe sizes required for the amount of BTU's for a new gas line installations. If you are using an existing gas line you must take into consideration the existing gas line capacities to ensure you will have proper pressure. **This chart is for reference only, we recommend you consult with a Licensed Plumber/Gas Fitter or NFPA54 (National Fuel Gas Code - current edition) for more details.**

VENT HOOD INFORMATION

AMD Direct 

VH36-2



SIZE: 36"
 DESCRIPTION: 36" VENT HOOD W/ SINGLE MOTOR
 TOTAL CFM: 1000
 LIGHTING: LED (QTY. 2)
 OUTER DIMENSIONS: 36"(W) X 30"(D) X 18"(H)
 POWER: C14 TYPE POWER CORD - 5 FT
 NOISE LEVEL: 58 dB
 DUCT SPECS: 8" DUCT (QTY. 1)



DUCT COVER: **VH36-2-DC**
 DESCRIPTION: 12" DUCT COVER FOR 36" VENT HOOD
 COMPATIBLE WITH: VH36-2, SSVH-36



TEMPLATE: **VH36-2-SPT**
 DESCRIPTION: 1/2" MOUNTING BRACKET (TEMPLATE) FOR 36" VENT HOOD
 COMPATIBLE WITH: VH36-2



4" SPACER: **VH36-2-SP4**
 DESCRIPTION: 4" SPACER BRACKET FOR 36" VENT HOOD
 COMPATIBLE WITH: VH36-2



8" SPACER: **VH36-2-SP8**
 DESCRIPTION: 8" SPACER BRACKET FOR 36" VENT HOOD
 COMPATIBLE WITH: VH36-2

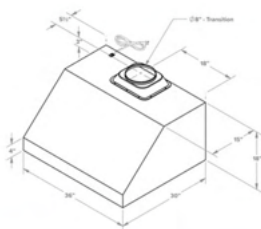

LINE DRAWING:

VH42-2



SIZE: 42"
 DESCRIPTION: 42" VENT HOOD W/ DUAL MOTORS
 TOTAL CFM: 2000
 LIGHTING: LED (QTY. 4)
 OUTER DIMENSIONS: 42"(W) X 30"(D) X 18"(H)
 POWER: C14 TYPE POWER CORD - 5 FT
 NOISE LEVEL: 62 dB
 DUCT SPECS: 8" DUCT (QTY. 2)



DUCT COVER: **VH42-2-DC**
 DESCRIPTION: 12" DUCT COVER FOR 42" VENT HOOD
 COMPATIBLE WITH: VH42-2



TEMPLATE: **VH42-2-SPT**
 DESCRIPTION: 1/2" MOUNTING BRACKET (TEMPLATE) FOR 42" VENT HOOD
 COMPATIBLE WITH: VH42-2



4" SPACER: **VH42-2-SP4**
 DESCRIPTION: 4" SPACER BRACKET FOR 42" VENT HOOD
 COMPATIBLE WITH: VH42-2



8" SPACER: **VH42-2-SP8**
 DESCRIPTION: 8" SPACER BRACKET FOR 42" VENT HOOD
 COMPATIBLE WITH: VH42-2

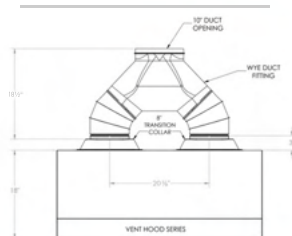
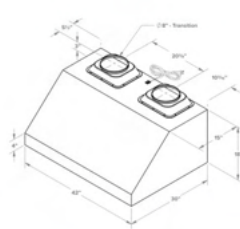

VH42-2-WDF

VH48-2



SIZE: 48"
 DESCRIPTION: 48" VENT HOOD W/ DUAL MOTORS
 TOTAL CFM: 2000
 LIGHTING: LED (QTY. 4)
 OUTER DIMENSIONS: 48"(W) X 30"(D) X 18"(H)
 POWER: C14 TYPE POWER CORD - 5 FT
 NOISE LEVEL: 62 dB
 DUCT SPECS: 8" DUCT (QTY. 2)



DUCT COVER: **VH48-2-DC**
 DESCRIPTION: 12" DUCT COVER FOR 48" VENT HOOD
 COMPATIBLE WITH: VH48-2, SSVH-48



TEMPLATE: **VH48-2-SPT**
 DESCRIPTION: 1/2" MOUNTING BRACKET (TEMPLATE) FOR 48" VENT HOOD
 COMPATIBLE WITH: VH48-2



4" SPACER: **VH48-2-SP4**
 DESCRIPTION: 4" SPACER BRACKET FOR 48" VENT HOOD
 COMPATIBLE WITH: VH48-2



8" SPACER: **VH48-2-SP8**
 DESCRIPTION: 8" SPACER BRACKET FOR 48" VENT HOOD
 COMPATIBLE WITH: VH48-2

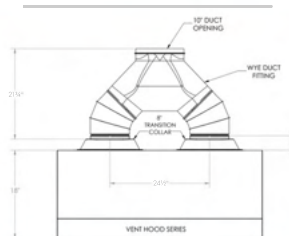
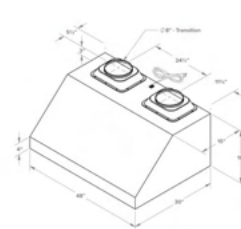

VH48-2-WDF

VH60-2



SIZE: 60"
 DESCRIPTION: 60" VENT HOOD W/ DUAL MOTORS
 TOTAL CFM: 2000
 LIGHTING: LED (QTY. 4)
 OUTER DIMENSIONS: 60"(W) X 30"(D) X 18"(H)
 POWER: C14 TYPE POWER CORD - 5 FT
 NOISE LEVEL: 62 dB
 DUCT SPECS: 8" DUCT (QTY. 2)



DUCT COVER: **VH60-2-DC**
 DESCRIPTION: 12" DUCT COVER FOR 60" VENT HOOD
 COMPATIBLE WITH: VH60-2, SSVH-60



TEMPLATE: **VH60-2-SPT**
 DESCRIPTION: 1/2" MOUNTING BRACKET (TEMPLATE) FOR 60" VENT HOOD
 COMPATIBLE WITH: VH60-2



4" SPACER: **VH60-2-SP4**
 DESCRIPTION: 4" SPACER BRACKET FOR 60" VENT HOOD
 COMPATIBLE WITH: VH60-2



8" SPACER: **VH60-2-SP8**
 DESCRIPTION: 8" SPACER BRACKET FOR 60" VENT HOOD
 COMPATIBLE WITH: VH60-2

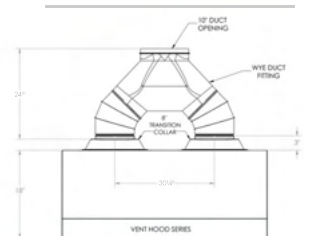
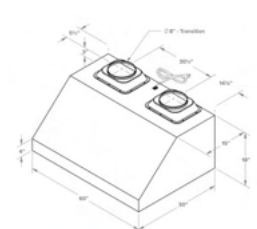

VH60-2-WDF

VENT DUCT TRANSITION:

REFRIGERATION

AMD Direct offers a wide variety of luxury Stainless Steel Refrigerators. With up to 5.3 cubic feet of storage, these appliances will help keep your food fresh, wine chilled, and beer cold, bringing the function of your indoor refrigeration outside to join the party!



15" 3.2C OUTDOOR RATED REFRIGERATOR
RFR-15C

- Storage Capacity: 3.2 ft³
- 32" - 50" Temperature Range
- Self-Closing #304 Stainless Steel Door & Handle



15" 3.2C OUTDOOR RATED REFRIGERATOR WITH GLASS DOOR
RFR-15CG

- Storage Capacity: 3.2 ft³
- 32" - 50" Temperature Range
- Black Interior
- Triple-Glazed Self-Closing Glass Door w/ #304 Stainless Steel Frame & Handle



24" 5.3C DELUXE OUTDOOR RATED SINGLE ZONE WINE COOLER
RFR-24W

- Storage Capacity: 5.3 ft³
- 46 Bottle Capacity
- Temperature Range: 47°-64°



24" 5.3C DELUXE OUTDOOR RATED DUAL ZONE WINE COOLER
RFR-24WD

- Storage Capacity: 5.3 ft³
- 46 Bottle Capacity
- Upper Temperature Range: 47°-50°
- Lower Temperature Range: 50°-64°



22" 4.1 Cu. DELUXE COMPACT REFRIGERATOR
RFR-22D / RFR-22D-R

- 156 Can Capacity
- Loading Door
- Right to Left Opening Model (RFR-22D-R)
- Upgraded Deluxe #304 Stainless Steel Door & Handle



22" 4.1 Cu. COMPACT REFRIGERATOR
RFR-22C

- 156 Can Capacity
- #304 Stainless Steel Reversible Door
- Loading Door



15" 3.2C OUTDOOR RATED SINGLE ZONE WINE COOLER
RFR-15W

- Storage Capacity: 3.2 ft³
- 28 Bottle Capacity
- 47° - 64° Temperature Range



15" 3.2C OUTDOOR RATED DUAL ZONE WINE COOLER
RFR-15WD

- Storage Capacity: 3.2 ft³
- 28 Bottle Capacity
- Upper Temperature Range: 47°-50°
- Lower Temperature Range: 50°-64°



24" 5.3C DELUXE OUTDOOR RATED REFRIGERATOR
RFR-24D / RFR-24D-R

- Storage Capacity: 5.3 ft³
- 185 Can Capacity
- 32" - 50" Temperature Range
- Self-Closing #304 Stainless Steel Door, Body & Handle
- Left & Right Doors Available



24" 5 Cu. OUTDOOR RATED DOUBLE DRAWER REFRIGERATOR
RFR-24DR2A

- 114 Can Capacity
- Black Interior Cabinet w/ Stainless Steel Drawer
- Soft-Closing Drawers



SINGLE KEG TAP FOR KEGERATOR
RFR-1TAP1

- Fits RFR-24DK
- Includes Tap, Tray, Single Hose, CO2 Kit (Tank & Regulator)



DOUBLE KEG TAP FOR KEGERATOR
RFR-1TAP2

- Fits SSRFR-24DK
- Includes Tap, Tray, Two Hoses, CO2 Kit (Tank & Regulator)



24" 5 Cu. OUTDOOR RATED REFRIGERATOR WITH GLASS DOOR
RFR-24GA / RFR-24GA-AR

- 161 Can Capacity
- Glass Drawers (x3)
- Black Exterior & Interior Cabinet
- Right to Left Opening Door Model (RFR-24GA-AR)



24" 5 Cu. OUTDOOR RATED REFRIGERATOR
RFR-24G

- 161 Can Capacity
- Glass Drawers (x3)
- Black Exterior & Interior Cabinet
- Triple-Glazed, Tinted Glass Door



24" 6.6C DELUXE OUTDOOR RATED KEGERATOR (NO TAP / SINGLE TAP / DOUBLE TAP)
RFR-24DK / RFR-24DK1 / RFR-24DK2

- Storage Capacity: 6.6 ft³
- Available in Single or Double Tap Towers
- 32" - 50" Temperature Range
- Self-Closing #304 Stainless Steel Door, Body & Handle
- Left & Right Doors Available

CARE & CLEANING

INITIAL CLEANING AFTER INSTALLATION

- When first installed, remove all protective plastic as soon as possible.
- Clean the exterior stainless steel with stainless steel cleaner (Bar Keeper's Friend, Zep, or others) right after installation.
- Clean the exterior regularly.
- Turn on the main bottom burners for 10 minutes to burn off any production oils inside the side burner.
- Interior cleaning is suggested at a minimum of once per season (using Simple Green) and an annual deep interior cleaning.

MONTHLY INTERIOR CLEANING

- Turn the side burner on high for 15 minutes and close the hood, similar to self-cleaning ovens, to burn up and break down any interior buildup of grease and food residue.
- Let the side burner cool down for roughly 90 minutes.
- Remove the cooking grates and soak them in a bucket of warm water with Simple Green to remove baked-on grime and grease.
- Remove the drip tray and scrape off any residue. Then, spray with Simple Green and hose it off.
- Remove the briquette tray and brush off any residue.
- Wipe down the interior walls around the back burner and side walls using a degreaser or stainless steel cleaner for ovens and side burners.
- Remove the bottom burners. Lightly brush them off with a stainless steel brush, and clean out the holes in the burners, ensuring none are clogged.
- Turn and tap the burners with the main inlet hole down to remove debris from inside.
- Use a stainless steel brush or putty knife to scrape down the interior basin of the side burner.
- Using a shop vac, vacuum out the residue from the bottom basin of the side burner.
- If desired, hose out the inside of the side burner and let it dry before reinstalling the interior parts.
- After each use, burn off debris and brush clean.

EXTERIOR STAINLESS STEEL CLEANING

- Fill a bucket with warm water and soap (Dawn or Simple Green).
- Using a microfiber towel or sponge moistened with soapy water, wipe down the surface of the side burner following the grain of the metal as you clean.
- Rinse completely with clean water.
- Dry with a microfiber towel.
- Using Bar Keeper's Friend, Zep, or other quality stainless steel cleaners helps to protect the porous stainless steel surface from discoloration.
- Covering the side burner with a side burner cover when not in use is a great way to protect the exterior.

RUST INFORMATION

Rust-like brown spots are formed when oxygen comes into sustained contact with iron in a process called oxidation. Oxygen is delivered to the metal from water, either from liquid water or water vapor (rain or humidity). Carbon dioxide in the air combines with the water to form a weak carbonic acid, which breaks down into hydrogen and oxygen. This process, along with some of the minerals and other particles in the air, can form rust-like deposits on the surface of the porous stainless steel, resulting in brown spots. Another cause is that free oxygen bonds with the dissolved minerals and other particles in the air to form iron oxide, or rust-like spots, in the pores.

Rust-like brown spot formations can also be encouraged by architectural crevices, such as the polished welds and edges of the metal surface, that can trap liquids. Once rust-like brown spots form, the porous surface can trap additional liquids, leading to further deposits on the stainless steel surface.

Regularly cleaning the exterior surface with a stainless steel cleaner, by spraying it on a clean microfiber towel or cloth and wiping off the entire outside surface, can help clean the pores. This regular cleaning should help keep the stainless steel looking new, similar to waxing the paint surface of a car.

The purchase and use of top-rated stainless steel cleaners and polishers, along with stainless steel finish restoration cleaners and refinishers, may be necessary.

REMOVE RUST LOOKING STAINS OR SPOTS

- Mix 1 tablespoon of baking soda in 2 cups of water.
- Rub the baking soda solution on the rust stain using a toothbrush, being careful to go with the grain of the stainless steel. If the stain is persistent, add vinegar, little by little, to a cup of baking soda until you have a consistent paste. Wipe the spot with paste and rinse with a wet microfiber towel. Making certain you always wipe in the direction of the grain of the stainless steel
- When stain is removed, wash entire surface with the soap solution mentioned above. For grease build up, use Zep on the exterior surface to remove.

Page intentionally left blank



For more information visit:
SUMMERSETGRILLS.COM

**AMD Direct, Inc.
14520 DELTA LANE SUITE 105
HUNTINGTON BEACH, CA 92647
800.966.8126**